

# BCP56T1 Series

Preferred Devices

## NPN Silicon Epitaxial Transistor

These NPN Silicon Epitaxial transistors are designed for use in audio amplifier applications. The device is housed in the SOT-223 package, which is designed for medium power surface mount applications.

### Features

- High Current: 1.0 Amp
- The SOT-223 package can be soldered using wave or reflow. The formed leads absorb thermal stress during soldering, eliminating the possibility of damage to the die
- Available in 12 mm Tape and Reel
  - Use BCP56T1 to order the 7 inch/1000 unit reel
  - Use BCP56T3 to order the 13 inch/4000 unit reel
- PNP Complement is BCP53T1
- Pb-Free Packages are Available

### MAXIMUM RATINGS ( $T_C = 25^\circ\text{C}$ unless otherwise noted)

Rating	Symbol	Value	Unit
Collector-Emitter Voltage	$V_{CEO}$	80	Vdc
Collector-Base Voltage	$V_{CBO}$	100	Vdc
Emitter-Base Voltage	$V_{EBO}$	5	Vdc
Collector Current	$I_C$	1	Adc
Total Power Dissipation @ $T_A = 25^\circ\text{C}$ (Note 1) Derate above $25^\circ\text{C}$	$P_D$	1.5 12	W mW/ $^\circ\text{C}$
Operating and Storage Temperature Range	$T_J, T_{stg}$	-65 to 150	$^\circ\text{C}$

### THERMAL CHARACTERISTICS

Characteristic	Symbol	Max	Unit
Thermal Resistance, Junction-to-Ambient (surface mounted)	$R_{\theta JA}$	83.3	$^\circ\text{C}/\text{W}$
Maximum Temperature for Soldering Purposes Time in Solder Bath	$T_L$	260 10	$^\circ\text{C}$ Sec

Maximum ratings are those values beyond which device damage can occur. Maximum ratings applied to the device are individual stress limit values (not normal operating conditions) and are not valid simultaneously. If these limits are exceeded, device functional operation is not implied, damage may occur and reliability may be affected.

1. Device mounted on a FR-4 glass epoxy printed circuit board 1.575 in x 1.575 in x 0.0625 in; mounting pad for the collector lead = 0.93 sq in.



ON Semiconductor®

<http://onsemi.com>

## MEDIUM POWER NPN SILICON HIGH CURRENT TRANSISTOR SURFACE MOUNT

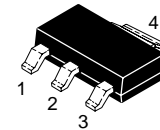
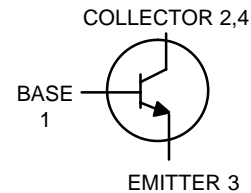

SOT-223  
CASE 318E  
STYLE 1

### MARKING DIAGRAM

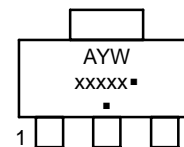

- xx = Specific Device Code
  - A = Assembly Location
  - Y = Year
  - W = Work Week
  - = Pb-Free Package
- (Note: Microdot may be in either location)

### ORDERING INFORMATION

See detailed ordering and shipping information in the package dimensions section on page 2 of this data sheet.

Preferred devices are recommended choices for future use and best overall value.

## BCP56T1 Series

### ELECTRICAL CHARACTERISTICS ( $T_A = 25^\circ\text{C}$ unless otherwise noted)

Characteristics	Symbol	Min	Typ	Max	Unit
<b>OFF CHARACTERISTICS</b>					
Collector–Base Breakdown Voltage ( $I_C = 100\ \mu\text{Adc}$ , $I_E = 0$ )	$V_{(BR)CBO}$	100	–	–	Vdc
Collector–Emitter Breakdown Voltage ( $I_C = 1.0\ \text{mAdc}$ , $I_B = 0$ )	$V_{(BR)CEO}$	80	–	–	Vdc
Emitter–Base Breakdown Voltage ( $I_E = 10\ \mu\text{Adc}$ , $I_C = 0$ )	$V_{(BR)EBO}$	5.0	–	–	Vdc
Collector–Base Cutoff Current ( $V_{CB} = 30\ \text{Vdc}$ , $I_E = 0$ )	$I_{CBO}$	–	–	100	nAdc
Emitter–Base Cutoff Current ( $V_{EB} = 5.0\ \text{Vdc}$ , $I_C = 0$ )	$I_{EBO}$	–	–	10	$\mu\text{Adc}$

### ON CHARACTERISTICS (Note 2)

DC Current Gain ( $I_C = 5.0\ \text{mA}$ , $V_{CE} = 2.0\ \text{V}$ ) ( $I_C = 150\ \text{mA}$ , $V_{CE} = 2.0\ \text{V}$ )  ( $I_C = 500\ \text{mA}$ , $V_{CE} = 2.0\ \text{V}$ )	All Part Types BCP56T1 BCP56-10T1 BCP56-16T1 All Types	$h_{FE}$	25 40 63 100 25	– – – – –	– 250 160 250 –	–
Collector–Emitter Saturation Voltage ( $I_C = 500\ \text{mAdc}$ , $I_B = 50\ \text{mAdc}$ )		$V_{CE(sat)}$	–	–	0.5	Vdc
Base–Emitter On Voltage ( $I_C = 500\ \text{mAdc}$ , $V_{CE} = 2.0\ \text{Vdc}$ )		$V_{BE(on)}$	–	–	1.0	Vdc

### DYNAMIC CHARACTERISTICS

Current–Gain – Bandwidth Product ( $I_C = 10\ \text{mAdc}$ , $V_{CE} = 5.0\ \text{Vdc}$ , $f = 35\ \text{MHz}$ )	$f_T$	–	130	–	MHz
---------------------------------------------------------------------------------------------------------------------	-------	---	-----	---	-----

2. Pulse Test: Pulse Width  $\leq 300\ \mu\text{s}$ , Duty Cycle  $\leq 2.0\%$

### ORDERING INFORMATION

Device	Marking	Package	Shipping <sup>†</sup>
BCP56T1	BH	SOT–223	1000 / Tape & Reel
BCP56T1G	BH	SOT–223 (Pb–Free)	1000 / Tape & Reel
BCP56T3	BH	SOT–223	4000 / Tape & Reel
BCP56T3G	BH	SOT–223 (Pb–Free)	4000 / Tape & Reel
BCP56–10T1	BH–10	SOT–223	1000 / Tape & Reel
BCP56–10T1G	BH–10	SOT–223 (Pb–Free)	1000 / Tape & Reel
BCP56–16T1	BH–16	SOT–223	1000 / Tape & Reel
BCP56–16T1G	BH–16	SOT–223 (Pb–Free)	1000 / Tape & Reel
BCP56–16T3	BH–16	SOT–223	4000 / Tape & Reel
BCP56–16T3G	BH–16	SOT–223 (Pb–Free)	4000 / Tape & Reel

<sup>†</sup>For information on tape and reel specifications, including part orientation and tape sizes, please refer to our Tape and Reel Packaging Specifications Brochure, BRD8011/D.

# BCP56T1 Series

## TYPICAL ELECTRICAL CHARACTERISTICS

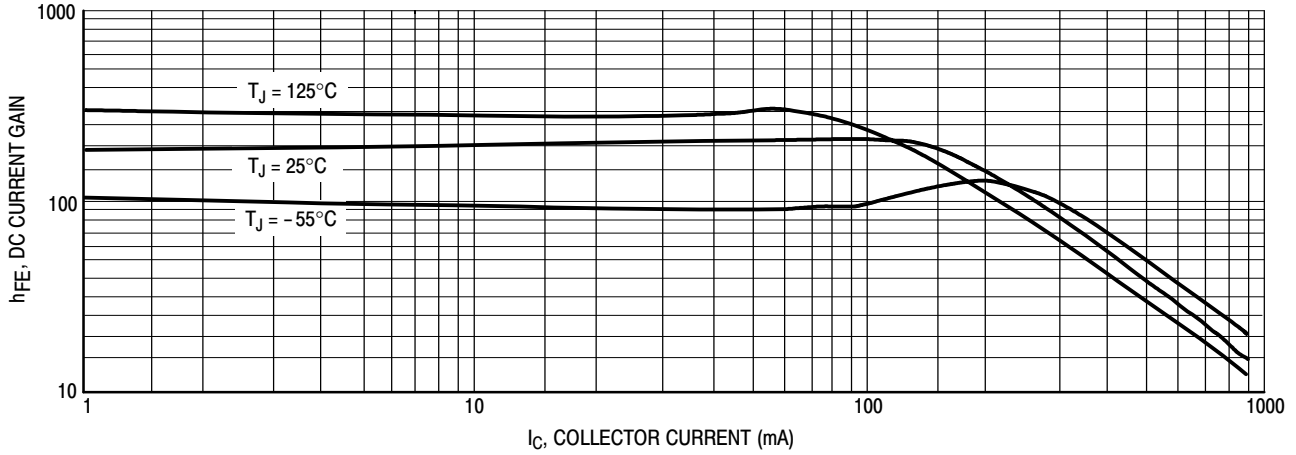

Figure 1. DC Current Gain

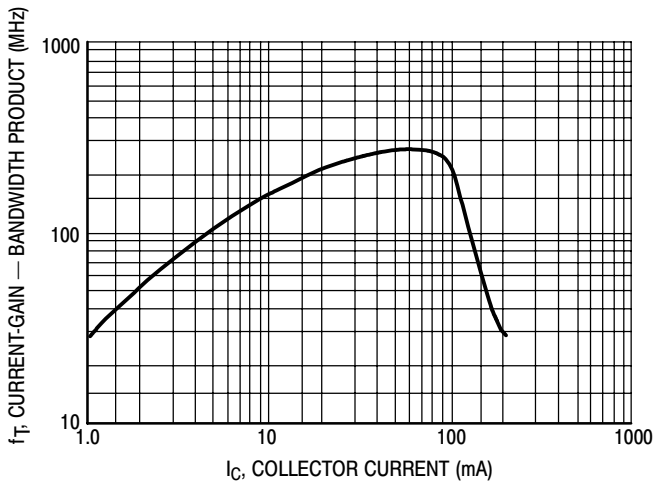

Figure 2. Current-Gain - Bandwidth Product

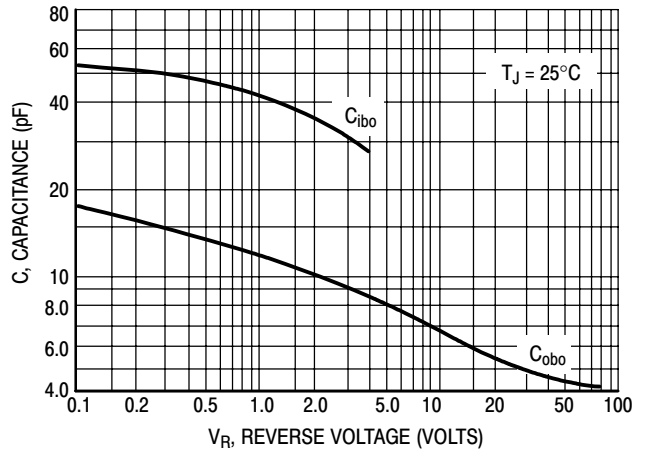

Figure 3. Capacitance

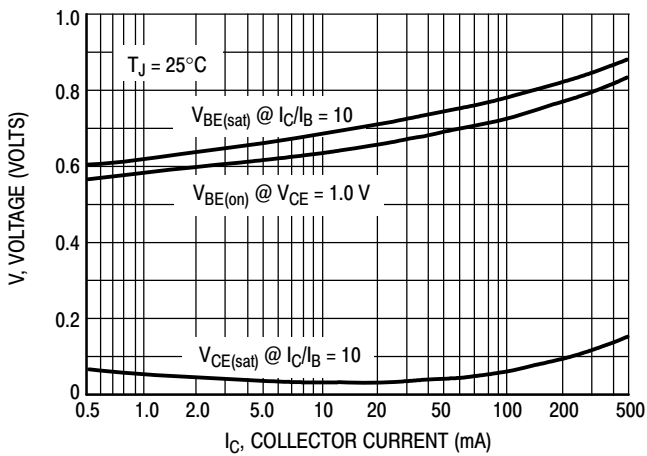

Figure 4. "On" Voltages

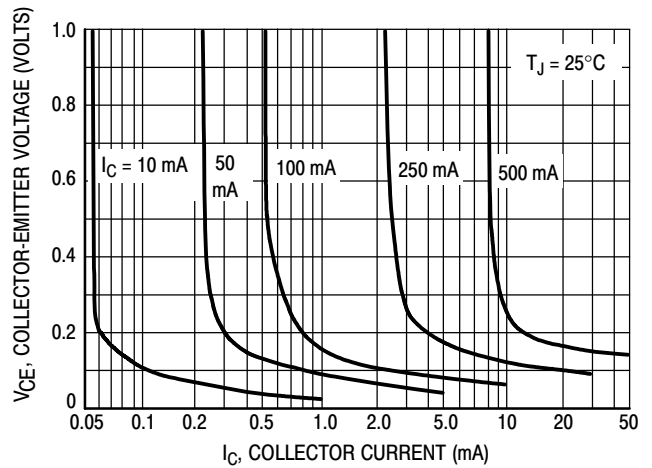
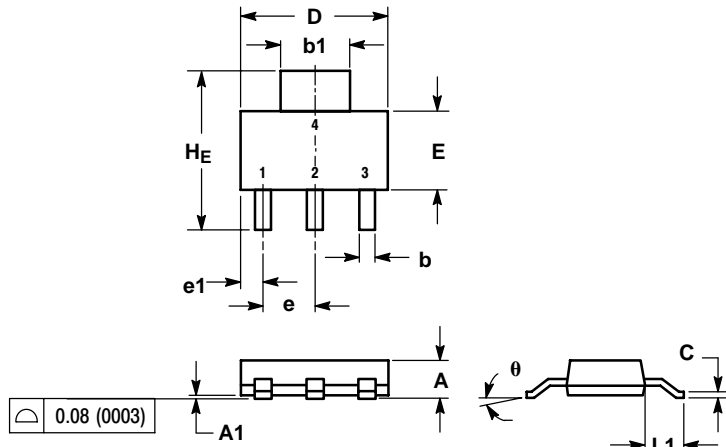

Figure 5. Collector Saturation Region

# BCP56T1 Series

## PACKAGE DIMENSIONS

SOT-223 (TO-261)  
CASE 318E-04  
ISSUE L



- NOTES:  
1. DIMENSIONING AND TOLERANCING PER ANSI Y14.5M, 1982.  
2. CONTROLLING DIMENSION: INCH.

DIM	MILLIMETERS			INCHES		
	MIN	NOM	MAX	MIN	NOM	MAX
A	1.50	1.63	1.75	0.060	0.064	0.068
A1	0.02	0.06	0.10	0.001	0.002	0.004
b	0.60	0.75	0.89	0.024	0.030	0.035
b1	2.90	3.06	3.20	0.115	0.121	0.126
c	0.24	0.29	0.35	0.009	0.012	0.014
D	6.30	6.50	6.70	0.249	0.256	0.263
E	3.30	3.50	3.70	0.130	0.138	0.145
e	2.20	2.30	2.40	0.087	0.091	0.094
e1	0.85	0.94	1.05	0.033	0.037	0.041
L1	1.50	1.75	2.00	0.060	0.069	0.078
HE	6.70	7.00	7.30	0.264	0.276	0.287
θ	0°	-	10°	0°	-	10°

- STYLE 1:  
PIN 1. BASE  
2. COLLECTOR  
3. EMITTER  
4. COLLECTOR

### SOLDERING FOOTPRINT\*

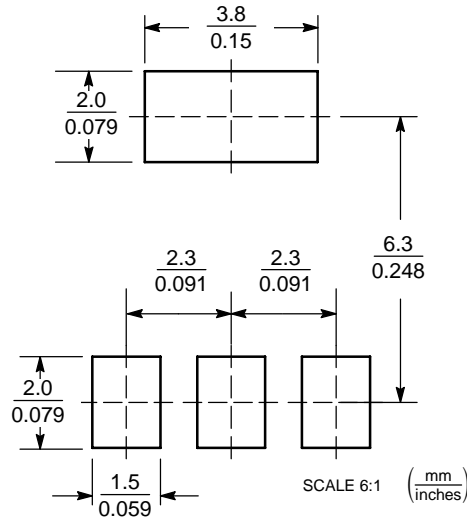

\*For additional information on our Pb-Free strategy and soldering details, please download the ON Semiconductor Soldering and Mounting Techniques Reference Manual, SOLDERRM/D.

ON Semiconductor and are registered trademarks of Semiconductor Components Industries, LLC (SCILLC). SCILLC reserves the right to make changes without further notice to any products herein. SCILLC makes no warranty, representation or guarantee regarding the suitability of its products for any particular purpose, nor does SCILLC assume any liability arising out of the application or use of any product or circuit, and specifically disclaims any and all liability, including without limitation special, consequential or incidental damages. "Typical" parameters which may be provided in SCILLC data sheets and/or specifications can and do vary in different applications and actual performance may vary over time. All operating parameters, including "Typicals" must be validated for each customer application by customer's technical experts. SCILLC does not convey any license under its patent rights nor the rights of others. SCILLC products are not designed, intended, or authorized for use as components in systems intended for surgical implant into the body, or other applications intended to support or sustain life, or for any other application in which the failure of the SCILLC product could create a situation where personal injury or death may occur. Should Buyer purchase or use SCILLC products for any such unintended or unauthorized application, Buyer shall indemnify and hold SCILLC and its officers, employees, subsidiaries, affiliates, and distributors harmless against all claims, costs, damages, and expenses, and reasonable attorney fees arising out of, directly or indirectly, any claim of personal injury or death associated with such unintended or unauthorized use, even if such claim alleges that SCILLC was negligent regarding the design or manufacture of the part. SCILLC is an Equal Opportunity/Affirmative Action Employer. This literature is subject to all applicable copyright laws and is not for resale in any manner.

### PUBLICATION ORDERING INFORMATION

LITERATURE FULFILLMENT:  
Literature Distribution Center for ON Semiconductor  
P.O. Box 61312, Phoenix, Arizona 85082-1312 USA  
Phone: 480-829-7710 or 800-344-3860 Toll Free USA/Canada  
Fax: 480-829-7709 or 800-344-3867 Toll Free USA/Canada  
Email: orderlit@onsemi.com

N. American Technical Support: 800-282-9855 Toll Free  
USA/Canada

Japan: ON Semiconductor, Japan Customer Focus Center  
2-9-1 Kamimeguro, Meguro-ku, Tokyo, Japan 153-0051  
Phone: 81-3-5773-3850

ON Semiconductor Website: <http://onsemi.com>

Order Literature: <http://www.onsemi.com/litorder>

For additional information, please contact your local Sales Representative.